

ROBOT ENCLOSURES

- Improve Safety
- Comply with Government and Industry Standards
- Protect Equipment

Custom Built by
Molders Choice
- or -
Do-It-Yourself-Kits



© 2000 MOLDERS CHOICE, Inc.

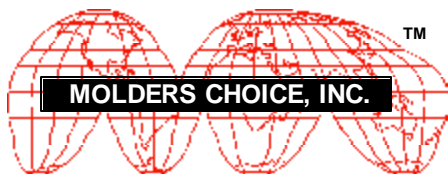

24 Hour Service - 7 Days a week
1-800-809-4623

WebSite: www.molderschoice.com • Email: molders@molderschoice.com

ROBOT ENCLOSURES

Protect Your Workers from Injury

Meet ANSI B151.27 and R15.06 specifications

Framing is rigid 40 mm or 50 mm extrusion of fine-grained, 6160-alloy aluminum.

Panels are wire mesh or 6 mm clear polycarbonate to endure rough usage, yet allow full view of robot. Wire mesh is flat -welded steel with PVC coating.

Angle fittings lock enclosure components into extremely rigid structure.

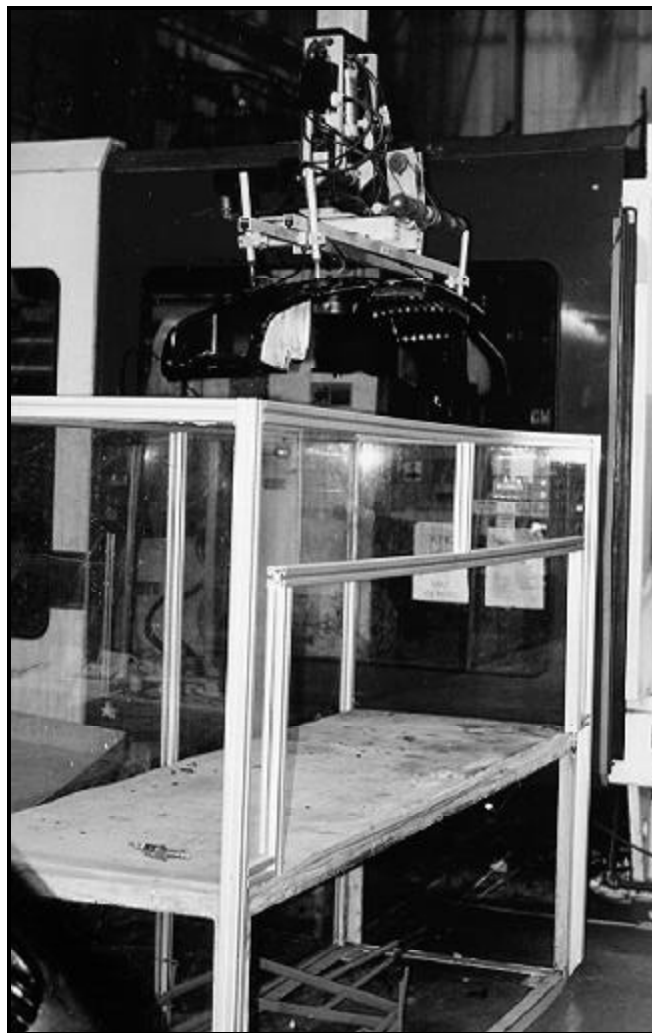
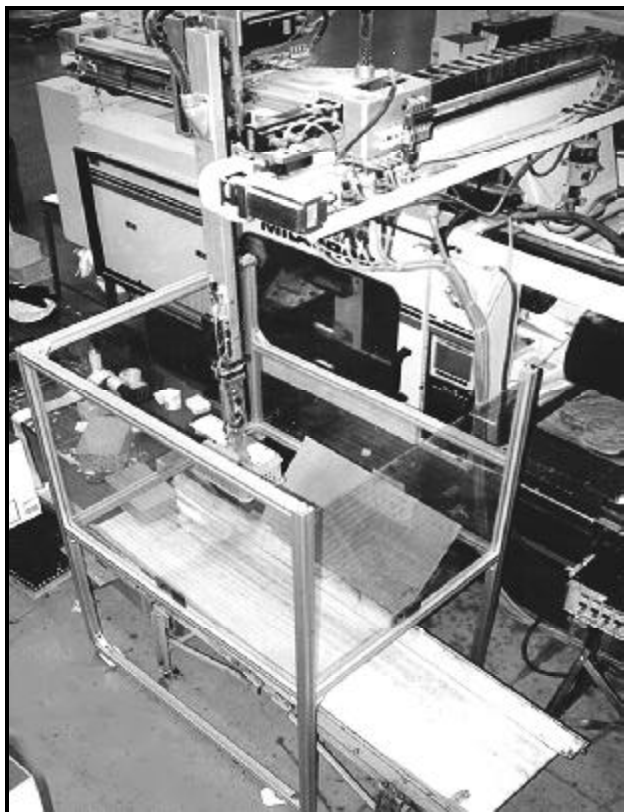

Interlocks are recommended for all enclosures and are required to meet ANSI specifications.

Mechanical Switches, Light Curtains, Photo-Eyes and Floormat-Type Safety Shutoffs are available from Molders Choice.

© 2000 MOLDERS CHOICE, Inc.



24 Hour Service - 7 Days a week

1-800-809-4623

WebSite: www.molderschoice.com • Email: molders@molderschoice.com

ROBOT ENCLOSURES



Protect Your Robots from Damage

Industrial-Quality Construction

Custom-made in 2 to 3 weeks.

Send us your sketch or layout for quote.

We design and build your enclosure, or we supply the materials for you to build it yourself.

Enclosure size must allow room for fully extended robot, plus end-of-arm tooling, plus largest part that might be carried, plus a safety zone to prevent workers from reaching robot from outside enclosure.

Normally, tops of enclosures are open. When there is a walkway above machine, top of enclosure must be closed.

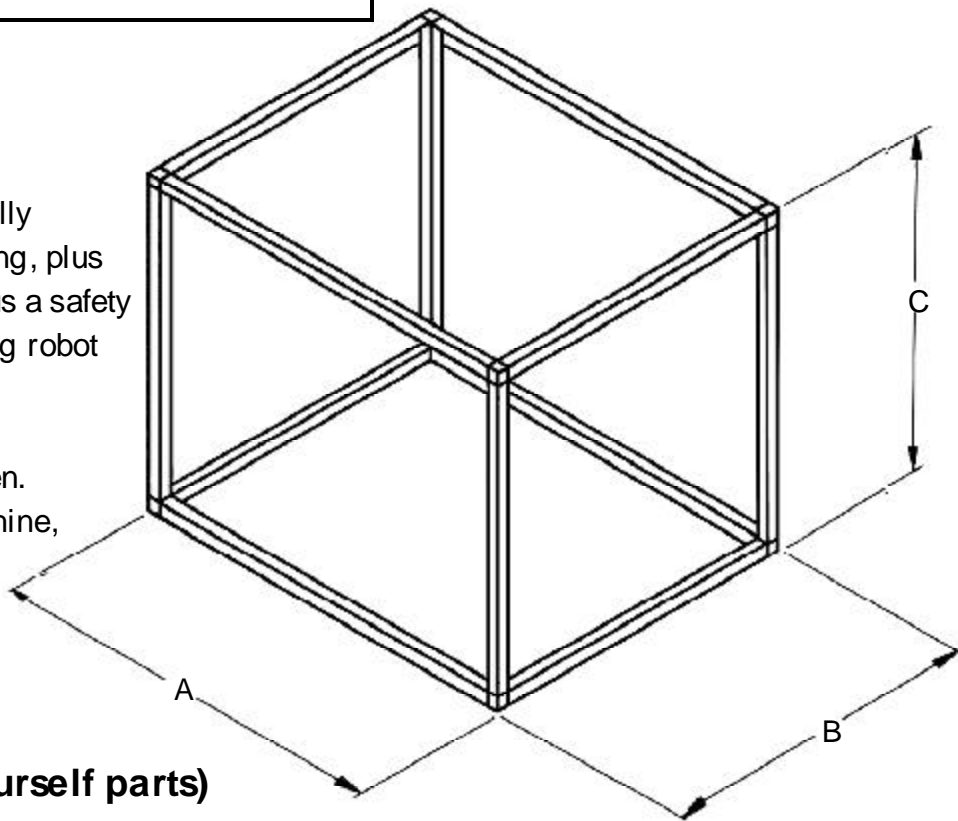

(See next page for Do-It-Yourself parts)

© 2000 MOLDERS CHOICE, Inc.



24 Hour Service - 7 Days a week

1-800-809-4623

WebSite: www.molderschoice.com • Email: molders@molderschoice.com

ROBOT ENCLOSURES COMPONENTS

Build-It-Yourself Components for Enclosures

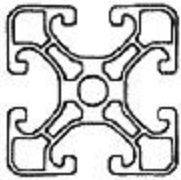

Part # **7000009**
#8 Profile
Natural finish
40 x 40 mm E
6m(19.7ft) long
\$84.00 ea

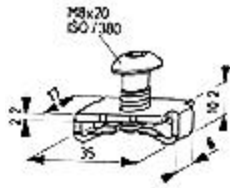

Part # **0002607**
#8 Std Fastening Set
Bright Zinc
40 x 40 mm
\$1.50 set

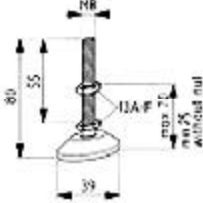

Part # **0036468**
D40 Knuckle Foot
Natural finish
8 x 60 mm
\$3.90 ea



Part # **0019645**
#8
Adjustable Foot
L-Base style
\$18.90 ea

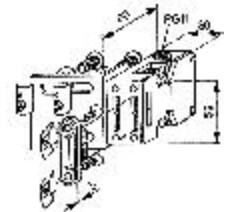

Part # **0026512**
#8 Security Limit Switch
with Fastening Set
\$51.20 ea

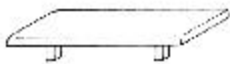

Part # **0002601**
#8 Cap
Black finish
\$1.50 ea

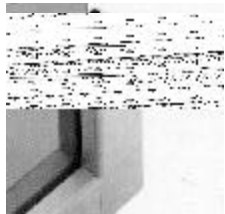

Part # **9000402**
1/4" x 4' x 8'
Clear Polycarbonate
Sheeting
\$190.20 sheet



Part # **0042838**
3.8mm Steel Mesh
Galvanized finish
40 x 40 mm E
\$126.00 ea

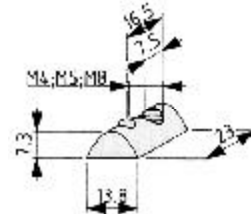

Part # **0002618**
#8 T-Slot Nut
M8
\$1.90 ea



Part # **0041115**
#8 Connection
Element Set
40 x 40 mm E
\$8.70 ea

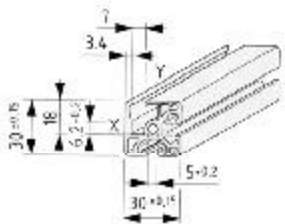

Part # **0043692**
#8 Clamp Profile
Natural finish
40 x 40 mm E
6m(19.7ft) long
\$159.00 ea

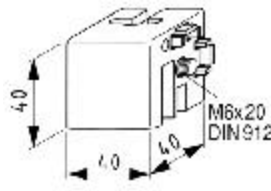

Part # **0044476**
#8 Clamping Profile
Fastener, Natural finish
40 x 40 mm E
\$13.50 set

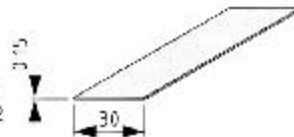

Part # **0044048**
#8 Clamp
Profile Tape
20 m(21.8 yds) long
\$48.00 roll

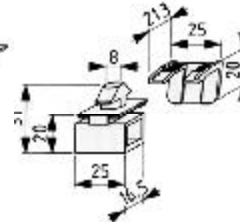

Part # **0019663**
#8
Clamp Multiblock
PA
\$2.50 ea

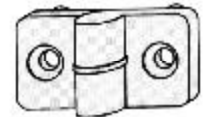

Part # **0002610**
#8 Hinge
PA, left
\$3.75 ea

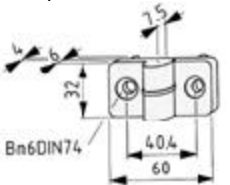

Part # **0002612**
#8 Hinge
PA, right
\$3.75 ea

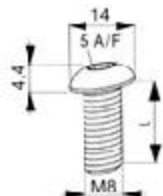

Part # **0019673**
M8 x 20
Button Head
Screw
\$30.20-100 pcs

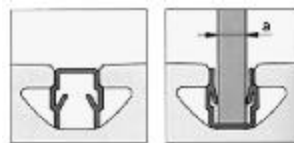

Part # **0042224**
#8 Cover Profile /
Panel-Fixing Profile
2m(78.7\"/>

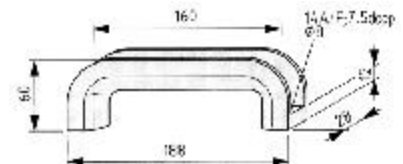

Part # **0019657**
#160
Handle PA
\$6.30 set

© 2000 MOLDERS CHOICE, Inc.



24 Hour Service - 7 Days a week
1-800-809-4623
 WebSite: www.molderschoice.com • Email: molders@molderschoice.com