

NOZZLE BODIES

Most popular thread sizes in stock,
Quick delivery on Specials!

Simply Change The Tip!!

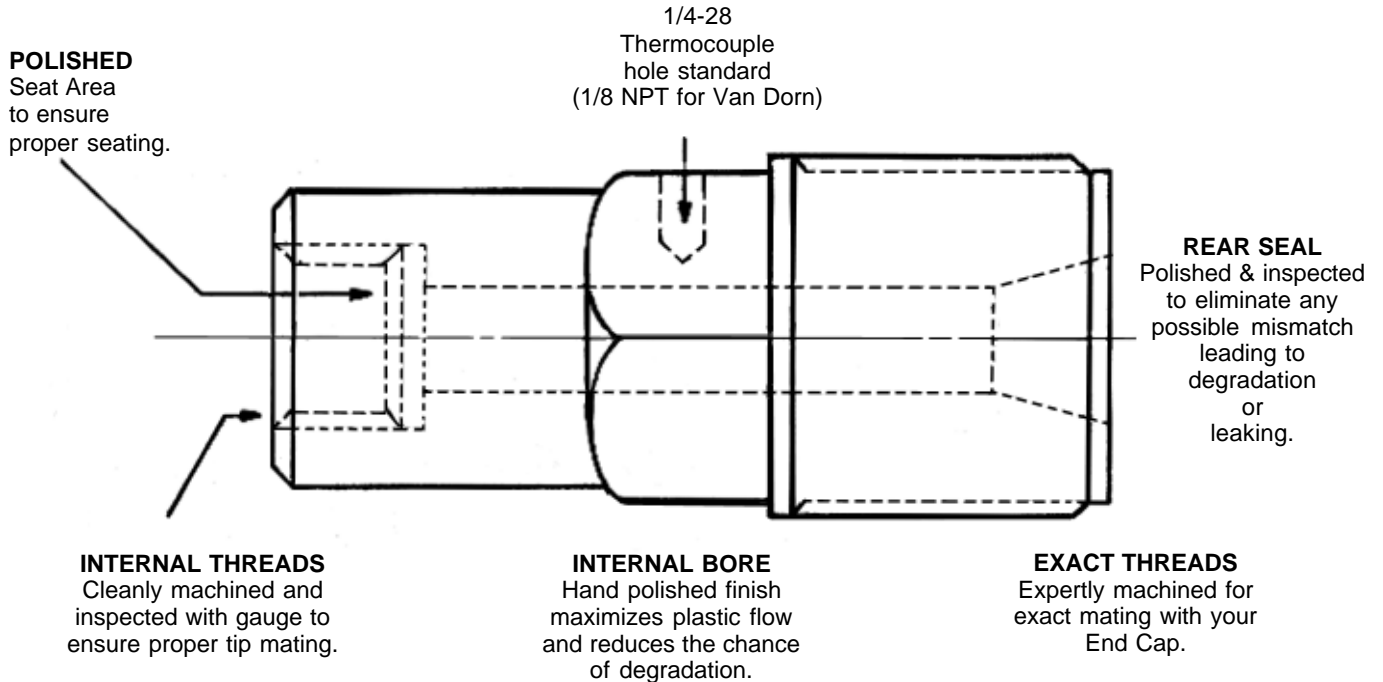

SPECIFICATIONS

- Alloy Steel 4140 or equivalent
- Heat Treated to 34-36 Rc for maximum toughness
- Super-smooth Internal finish - hand polished
- 100% Inspected
- Stocked in 5, 6, 7, 8, 9, 10, & 12" lengths
- For any make or model of machine
- All popular thread sizes in stock
- Can be customized to fit your application:
 - Special Thermocouple Holes
 - Pressure Transducer Holes
 - Melt Temperature Thermocouple Holes

See page 8 for special orders

© 2009 MOLDERS CHOICE, Inc.



24 Hour Service - 7 Days a week
1-800-809-4623
 WebSite: www.molderschoice.com • Email: molders@molderschoice.com

MOLDERS CHOICE NOZZLE BODIES

SPECIFICATIONS AND PRICING

All nozzle bodies are general purpose design and are stocked in various Thread Sizes and Rear Openings. Non-stocked items promptly made to order

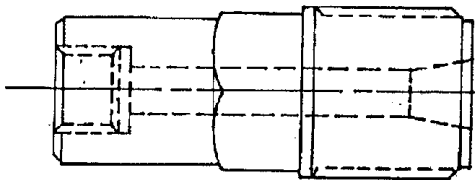
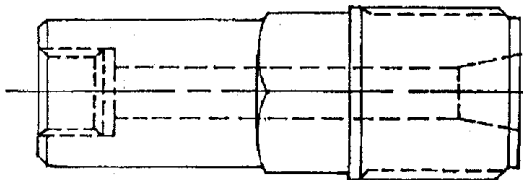
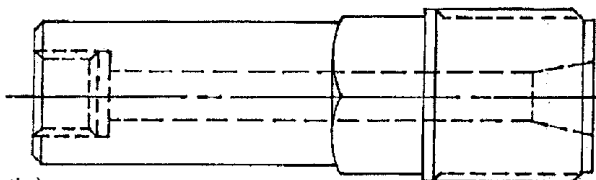
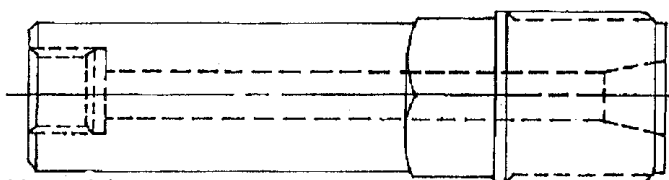
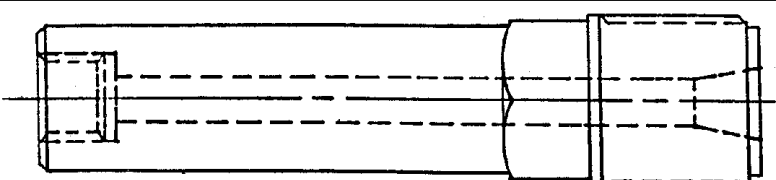
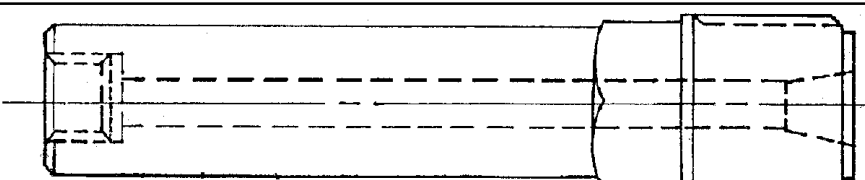
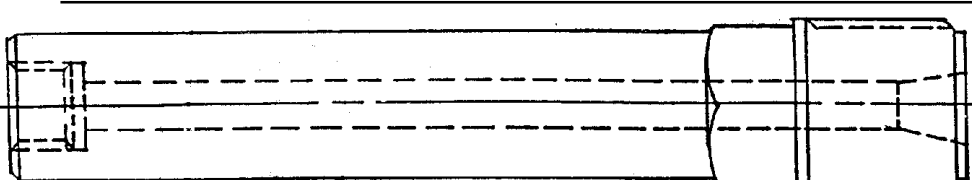
5" with Tip (4-1/4" without tip)		B-5 \$75.00	Recommended 1-1/2" x 1-1/2" Heater Band
6" with Tip (5-1/4" without tip)		B-6 \$78.00	Recommended 1-1/2" x 1-1/2" Heater Band
7" with Tip (6-1/4" without tip)		B-7 \$90.00	Recommended 1-1/2" x 3" Heater Band
8" with Tip (7-1/4" without tip)		B-8 \$118.00	Recommended 1-1/2" x 4" Heater Band
9" with Tip (8-1/4" without Tip)		B-9 \$125.00	Recommended 1-1/2" x 5" Heater Band
10" with Tip (9-1/4" without tip)		B-10 \$135.00	Recommended 1-1/2" x 6" Heater Band
12" with Tip (11-1/4" without tip)		B-12 \$145.00	Recommended 1-1/2" x 8-1/2" Heater Band



24 Hour Service - 7 Days a week
1-800-809-4623
 WebSite: www.molderschoice.com • Email: molders@molderschoice.com