

# 3/4" INLINE MANIFOLDS

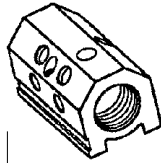

IM3-2-AB-4  
1/8" OR 1/4"  
**\$43.00**

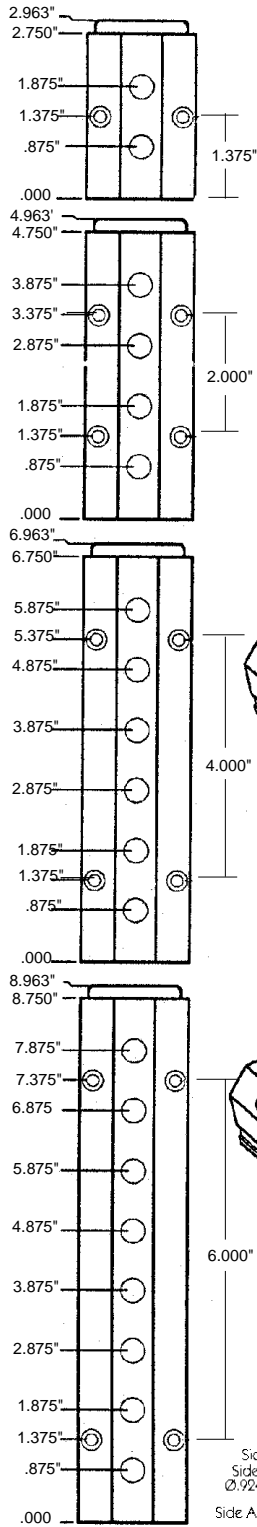
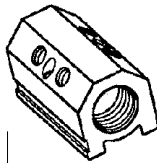

IM3-2-BD-4  
1/8" OR 1/4"  
**\$43.00**

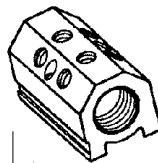

IM3-2-BCD-6  
1/8" OR 1/4"  
**\$48.00**

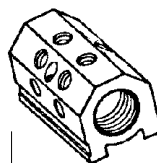

IM3-2-ABC-6  
1/8" OR 1/4"  
**\$49.00**

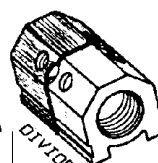

IM3-2-BD-2-2  
1/8" OR 1/4"  
**\$59.00**

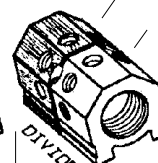

IM3-2-ABCDE-5-5  
1/8"  
**\$77.00**

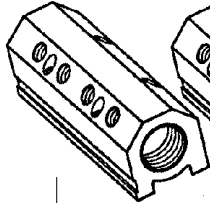

IM3-4-B-4  
1/8" OR 1/4"  
**\$53.00**

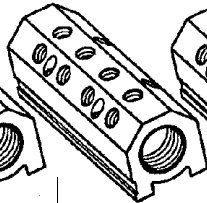

IM3-4-BC-8  
1/8" OR 1/4"  
**\$65.00**

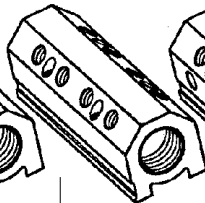

IM3-4-BD-8  
1/8" OR 1/4"  
**\$65.00**

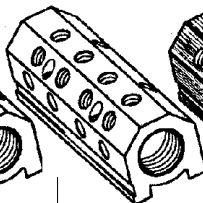

IM3-4-ABC-12  
1/8" OR 1/4"  
**\$77.00**

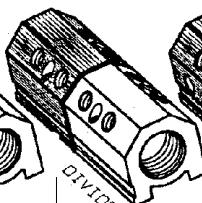

IM3-4-BD-4-4  
1/8" OR 1/4"  
**\$81.00**

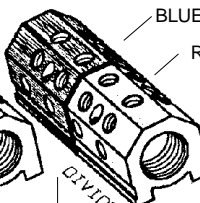

IM3-4-ABC-6-6  
1/8" OR 1/4"  
**\$93.00**

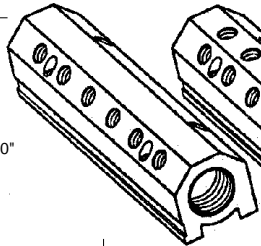

IM3-6-B-6  
1/8" OR 1/4"  
**\$69.00**

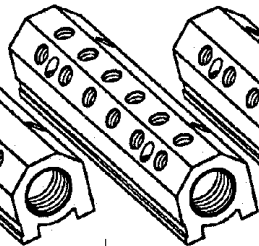

IM3-6-BC-12  
1/8" OR 1/4"  
**\$87.00**

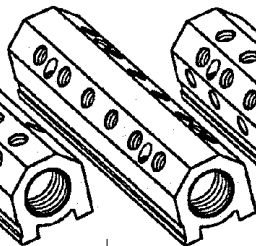

IM3-6-BD-12  
1/8" OR 1/4"  
**\$87.00**

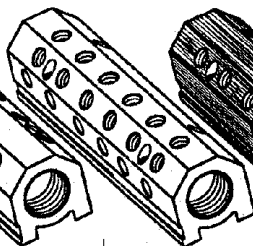

IM3-6-ABC-18  
1/8" OR 1/4"  
**\$105.00**

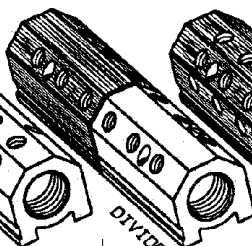

IM3-6-BD-6-6  
1/8" OR 1/4"  
**\$103.00**

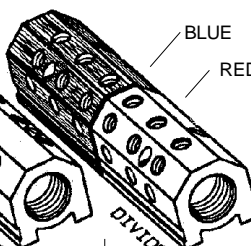

IM3-6-ABC-9-9  
1/8" OR 1/4"  
**\$121.00**

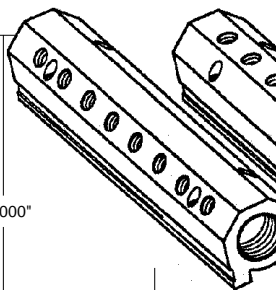

IM3-8-B-8  
1/8" OR 1/4"  
**\$85.00**

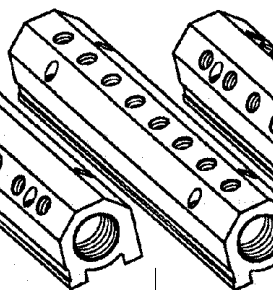

IM3-8-C-8  
1/8" OR 1/4"  
**\$85.00**

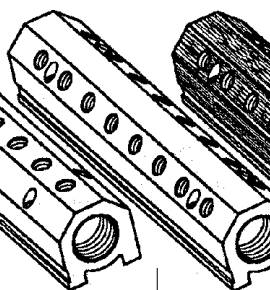

IM3-8-BD-16  
1/8" OR 1/4"  
**\$109.00**

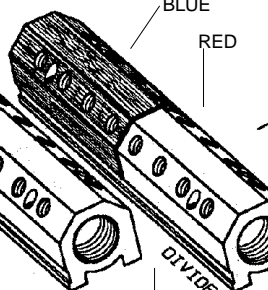

IM3-8-BD-8-8  
1/8" OR 1/4"  
**\$125.00**

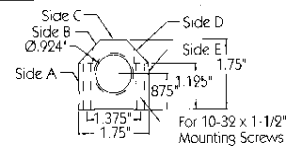

Price includes end cap and stainless steel 10-32 x 1-1/2" mounting screws.

**CUSTOM MANIFOLDS QUOTED UPON REQUEST**

© 2009 MOLDERS CHOICE, Inc.



24 Hour Service - 7 Days a week  
**1-800-809-4623**  
 WebSite: [www.molderschoice.com](http://www.molderschoice.com) • Email: [molders@molderschoice.com](mailto:molders@molderschoice.com)

# 1" INLINE MANIFOLDS

IM4-4-AB-4 1/4" OR 3/8" <b>\$56.00</b>	IM4-4-BD-4 1/4" OR 3/8" <b>\$56.00</b>	IM4-4-BCD-6 1/4" OR 3/8" <b>\$62.00</b>	IM4-4-ABC-6 1/4" OR 3/8" <b>\$62.00</b>	IM4-4-BD-2-2 1/4" OR 3/8" <b>\$73.00</b>	IM4-4-ABCDE-5-5 1/4" <b>\$91.00</b>
IM4-6-B-4 1/4" OR 3/8" <b>\$74.00</b>	IM4-6-BC-8 1/4" OR 3/8" <b>\$96.00</b>	IM4-6-BD-8 1/4" OR 3/8" <b>\$86.00</b>	IM4-6-ABC-12 1/4" OR 3/8" <b>\$98.00</b>	IM4-6-BD-4-4 1/4" OR 3/8" <b>\$103.00</b>	IM4-6-ABC-6-6 1/4" OR 3/8" <b>\$115.00</b>
IM4-9-B-6 1/4" OR 3/8" <b>\$92.00</b>	IM4-9-BC-12 1/4" OR 3/8" <b>\$110.00</b>	IM4-9-BD-12 1/4" OR 3/8" <b>\$110.00</b>	IM4-9-ABC-18 1/4" OR 3/8" <b>\$128.00</b>	IM4-9-BD-6-6 1/4" OR 3/8" <b>\$127.00</b>	IM4-9-ABC-9-9 1/4" OR 3/8" <b>\$145.00</b>
IM4-11-B-8 1/4" OR 3/8" <b>\$116.00</b>	IM4-11-C-8 1/4" OR 3/8" <b>\$116.00</b>	IM4-11-BD-16 1/4" OR 3/8" <b>\$140.00</b>	IM4-11-BD-8-8 1/4" OR 3/8" <b>\$157.00</b>	LENGTH 3.75" 6.25" 8.75" 11.25" OR SPECIAL	

Price includes end cap and stainless steel 1/4"-20 x 2" mounting screws

**CUSTOM MANIFOLDS QUOTED UPON REQUEST**

© 2009 MOLDERS CHOICE, Inc.



24 Hour Service - 7 Days a week

# 1-800-809-4623

WebSite: [www.molderschoice.com](http://www.molderschoice.com) • Email: [molders@molderschoice.com](mailto:molders@molderschoice.com)

# 1-1/2" INLINE MANIFOLDS

Part Number	Port Configuration	Price
IM6-6-AB-4	3/8" OR 1/2"	\$83.00
IM6-6-BD-4	3/8" OR 1/2"	\$83.00
IM6-6-BCD-6	3/8" OR 1/2"	\$91.00
IM6-6-ABC-6	3/8" OR 1/2"	\$91.00
IM6-6-BD-2-2	3/8" OR 1/2"	\$103.00
IM6-6-ABCDE-5-5	3/8" OR 1/2"	\$127.00
IM6-10-B-4	3/8" OR 1/2"	\$111.00
IM6-10-BC-8	3/8" OR 1/2"	\$127.00
IM6-10-BD-8	3/8" OR 1/2"	\$127.00
IM6-10-ABC-12	3/8" OR 1/2"	\$143.00
IM6-10-BD-4-4	3/8" OR 1/2"	\$147.00
IM6-10-ABC-6-6	3/8" OR 1/2"	\$163.00
IM6-14-B-8	3/8" OR 1/2"	\$147.00
IM6-14-BC-12	3/8" OR 1/2"	\$171.00
IM6-14-BD-12	3/8" OR 1/2"	\$171.00
IM6-14-ABC-18	3/8" OR 1/2"	\$195.00
IM6-14-BD-6-6	3/8" OR 1/2"	\$191.00
IM6-14-ABC-9-9	3/8" OR 1/2"	\$215.00
IM6-18-B-8	3/8" OR 1/2"	\$183.00
IM6-18-C-8	3/8" OR 1/2"	\$183.00
IM6-18-BD-16	3/8" OR 1/2"	\$215.00
IM6-18-ABC-12-12	3/8" OR 1/2"	\$267.00

Price includes end cap and stainless steel 1/4"-20 x 2-1/2" mounting screws  
**CUSTOM MANIFOLDS QUOTED UPON REQUEST**



© 2009 MOLDERS CHOICE, Inc.

24 Hour Service - 7 Days a week  
**1-800-809-4623**  
 WebSite: [www.molderschoice.com](http://www.molderschoice.com) • Email: [molders@molderschoice.com](mailto:molders@molderschoice.com)

# 2" INLINE MANIFOLDS

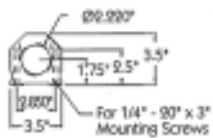
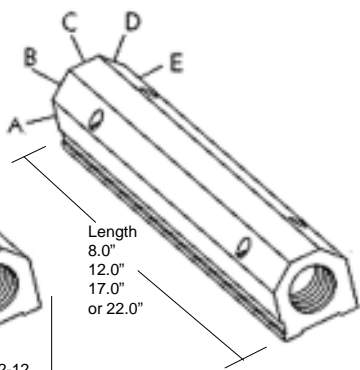
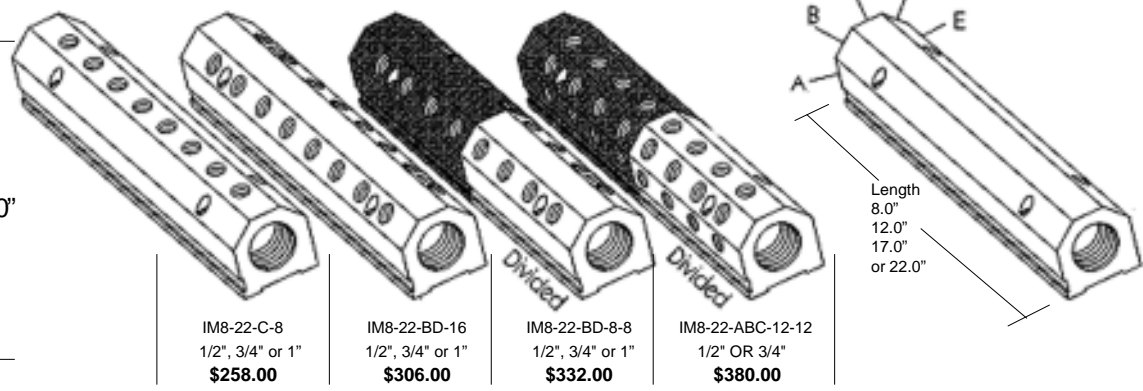
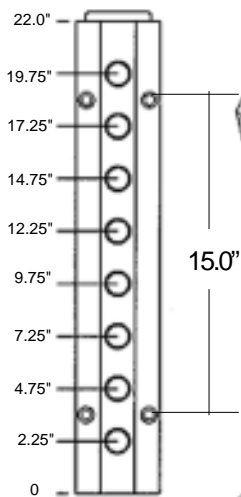
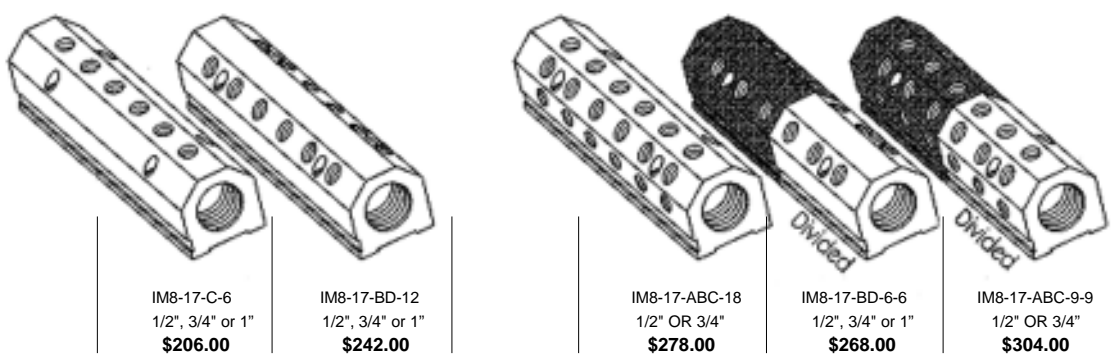
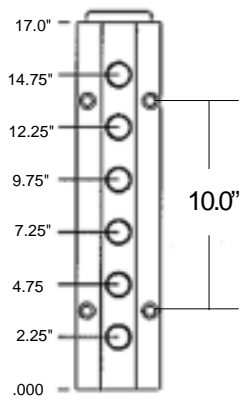
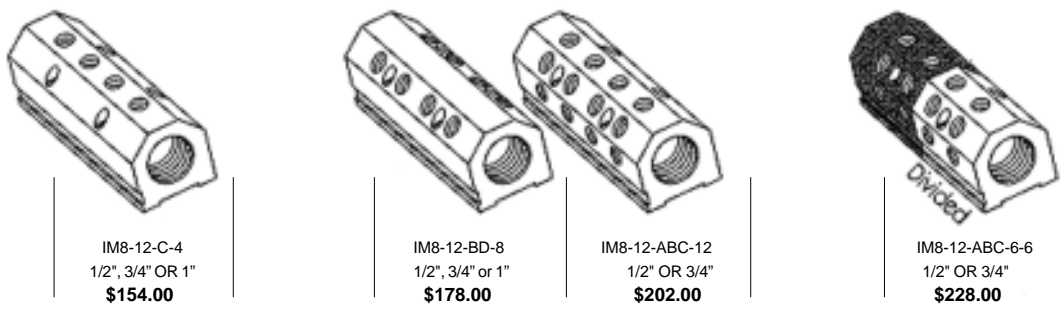
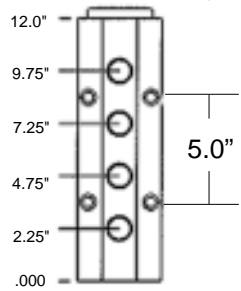
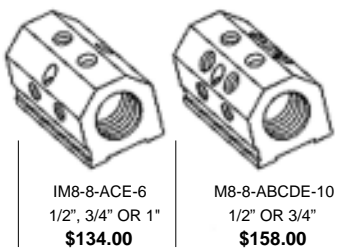
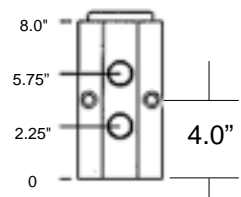

Price includes end cap and stainless steel 1/4" x 20 x 3" mounting screws.  
**CUSTOM MANIFOLDS QUOTED UPON REQUEST**

© 2009 MOLDERS CHOICE, Inc.



**24 Hour Service - 7 Days a week**  
1-800-809-4623  
 WebSite: [www.molderschoice.com](http://www.molderschoice.com) • Email: [molders@molderschoice.com](mailto:molders@molderschoice.com)

# 3/4" x 5" SIDELINE™ MANIFOLDS

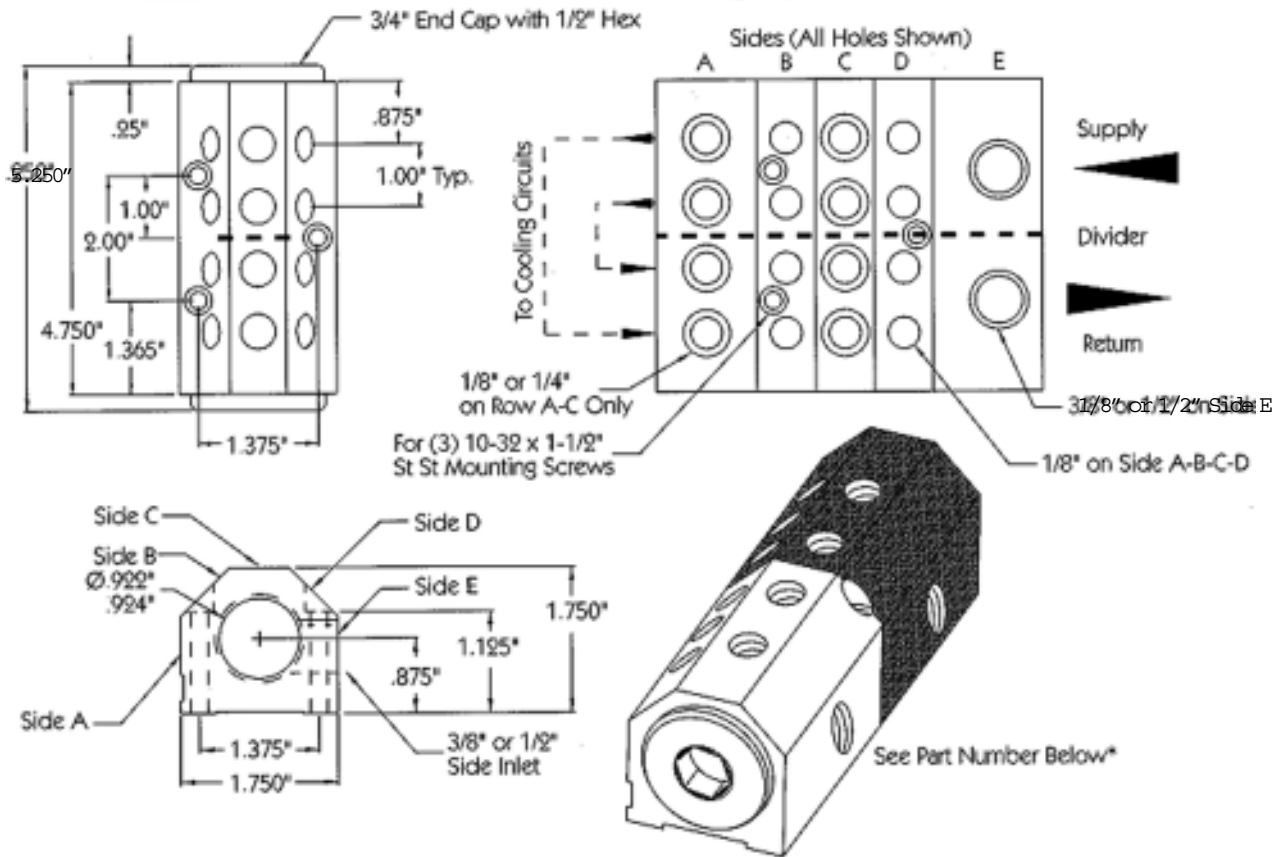

## 3/4 x 5 SIDELINE

Outgoing Ports					Part Number	Price
Side A In-Out	Side B In-Out	Side C In-Out	Side D In-Out	Side E In-Out		
1/8" Ports	1/8" Ports	1/8" Ports	1/8" Ports			
	Two-Two			3/8"-3/8"	IM3S-5-3/8-B-2-2-1/8-N-R/B	\$87.00
Two-Two	Two-Two			3/8"-3/8"	IM3S-5-3/8-AB-4-4-1/8-N-R/B	\$99.00
	Two-Two		Two-Two	3/8"-3/8"	*IM3S-5-3/8-BD-4-4-1/8-N-R/B	\$99.00
	Two-Two	Two-Two	Two-Two	3/8"-3/8"	IM3S-5-3/8-BCD-6-6-1/8-N-R/B	\$111.00
Two-Two	Two-Two	Two-Two	Two-Two	3/8"-3/8"	IM3S-5-3/8-ABCD-8-8-1/8-N-R/B	\$123.00
	1/4" Ports		1/4" Ports			
	Two-Two			1/2"-1/2"	IM3S-5-1/2-B-2-2-1/4-N-R/B	\$87.00
	Two-Two		Two-Two	1/2"-1/2"	IM3S-5-1/2-BD-4-4-1/4-N-R/B	\$99.00

Prices include end caps and (3) 10-32 x 1-1/2" mounting screws

© 2009 MOLDERS CHOICE, Inc.



**24 Hour Service - 7 Days a week**  
**1-800-809-4623**  
 WebSite: [www.molderschoice.com](http://www.molderschoice.com) • Email: [molders@molderschoice.com](mailto:molders@molderschoice.com)

# 1" x 7" SIDELINE™ MANIFOLDS

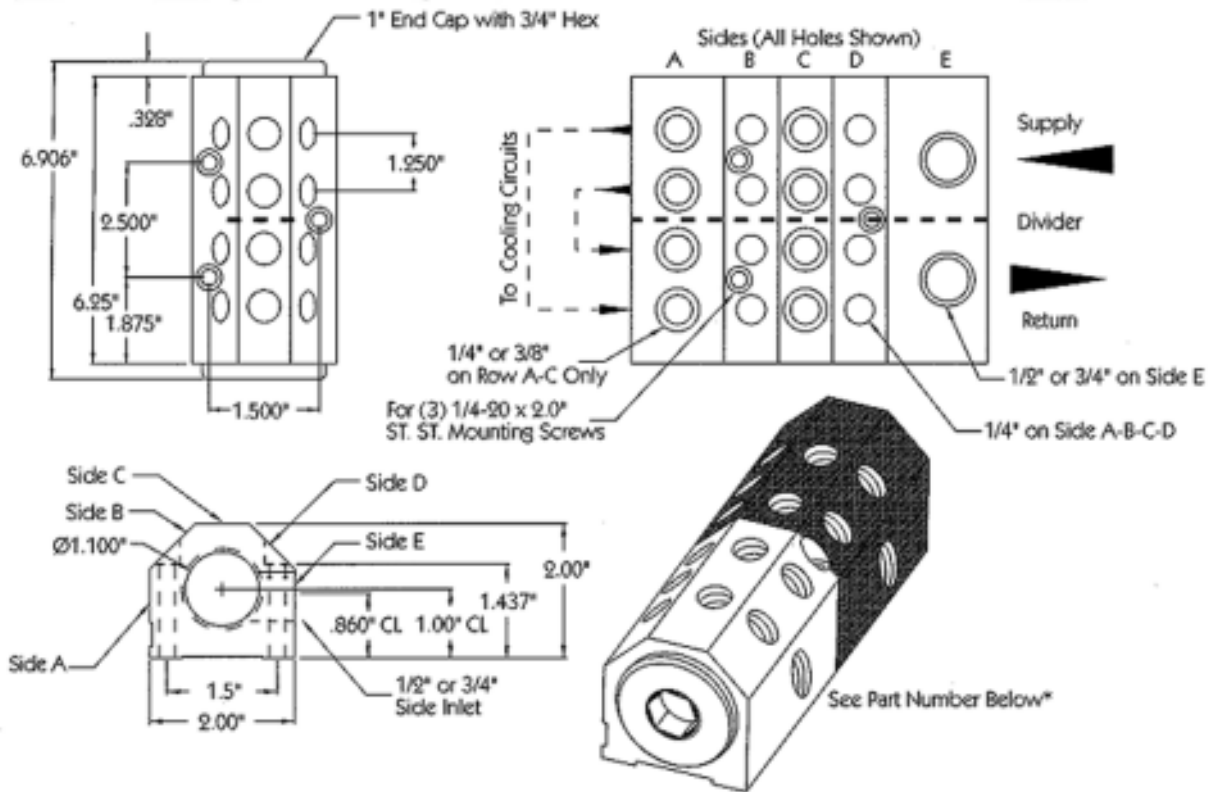

## 1 x 7 SIDELINE

Outgoing Ports					Part Number	Price
Side A In-Out	Side B In-Out	Side C In-Out	Side D In-Out	Side E In-Out		
1/4" Ports	1/4" Ports	1/4" Ports	1/4" Ports			
	Two-Two			1/2"-1/2"	IM4S-7-1/2-B-2-2-1/4-N-R/B	\$113.00
Two-Two	Two-Two			1/2"-1/2"	IM4S-7-1/2-AB-4-4-1/4-N-R/B	\$125.00
	Two-Two		Two-Two	1/2"-1/2"	IM4S-7-1/2-BD-4-4-1/4-N-R/B	\$125.00
	Two-Two	Two-Two	Two-Two	1/2"-1/2"	IM4S-7-1/2-BCD-6-6-1/4-N-R/B	\$137.00
Two-Two	Two-Two	Two-Two	Two-Two	1/2"-1/2"	IM4S-7-1/2-ABCD-8-8-1/4-N-R/B	\$149.00
	3/8" Ports		3/8" Ports			
	Two-Two			3/4'-3/4"	IM4S-3/4-B-2-3-8-NR/B	\$113.00
	Two-Two		Two-Two	3/4"-3/4"	IM4S-7-3/4-BD-4-4-3/8-N-R/B	\$125.00

Prices include end caps and (3) 10-32 x 2" mounting screws

© 2009 MOLDERS CHOICE, Inc.



24 Hour Service - 7 Days a week

## 1-800-809-4623

WebSite: [www.molderschoice.com](http://www.molderschoice.com) • Email: [molders@molderschoice.com](mailto:molders@molderschoice.com)

# 1-1/2" x 10" SIDELINE™ MANIFOLDS

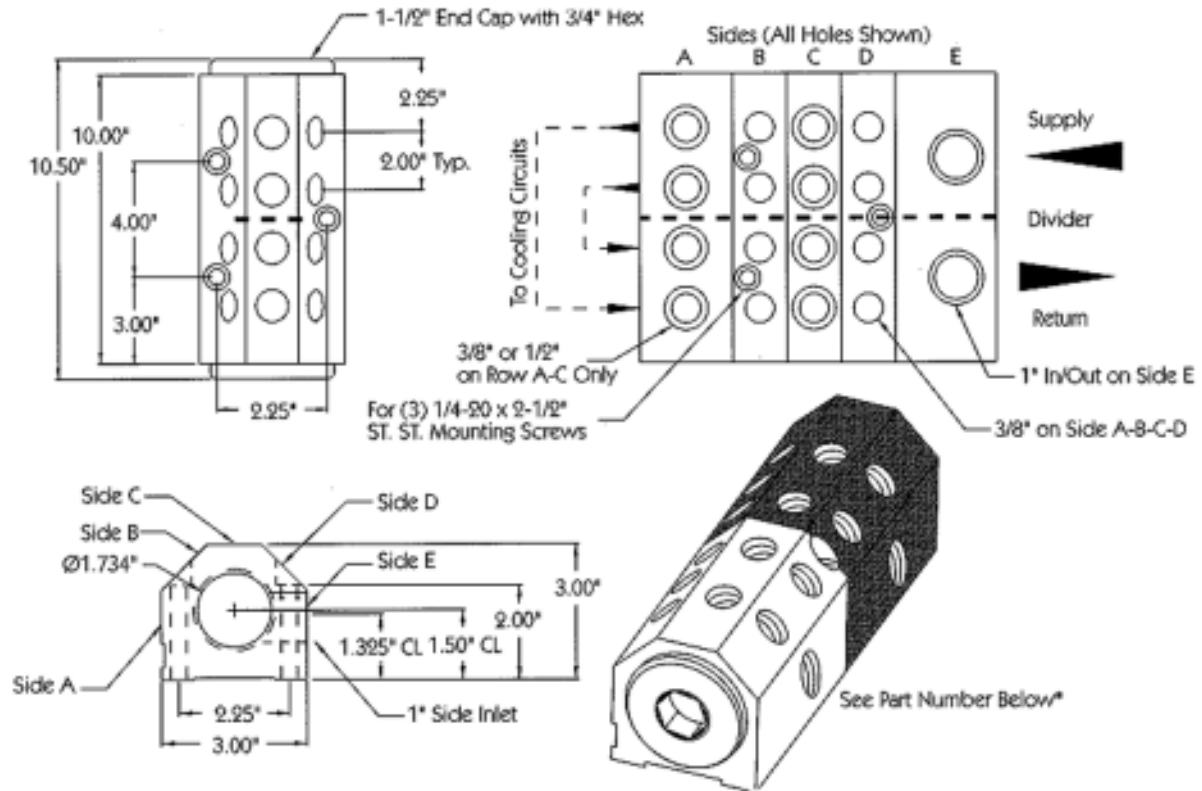

## 1-1/2" x 10" SIDELINE

Outgoing Ports					Part Number	Price
Side A In-Out	Side B In-Out	Side C In-Out	Side D In-Out	Side E In-Out		
3/8" Ports	3/8" Ports	3/8" Ports	3/8" Ports			
	Two-Two			1"-1"	IM6S-10-1-B-2-2-3/8-N-R/B	\$159.00
Two-Two	Two-Two			1"-1"	IM6S-10-1-AB-4-4-3/8-N-R/B	\$175.00
	Two-Two		Two-Two	1"-1"	IM6S-10-1-BD-4-4-3/8-N-R/B	\$175.00
	Two-Two	Two-Two	Two-Two	1"-1"	IM6S-10-1-ABC-6-6-3/8-N-R/B	\$191.00
Two-Two	Two-Two	Two-Two	Two-Two	1"-1"	*IM6S-10-1-ABCD-8-8-3/8-N-R/B	\$207.00
	1/2" Ports		1/2" Ports			
	Two-Two			1"-1"	IM6S-10-1-B-2-2-1/2-N-R/B	\$159.00
	Two-Two		Two-Two	1"-1"	IM6S-10-1-BD-4-4-1/2-N-R/B	\$175.00

Prices include end caps and (3) 1/4" X 20 x 2-1/2" mounting screws

© 2009 MOLDERS CHOICE, Inc.



24 Hour Service - 7 Days a week  
**1-800-809-4623**  
 WebSite: [www.molderschoice.com](http://www.molderschoice.com) • Email: [molders@molderschoice.com](mailto:molders@molderschoice.com)

# 2" x 12" SIDELINE™ MANIFOLDS

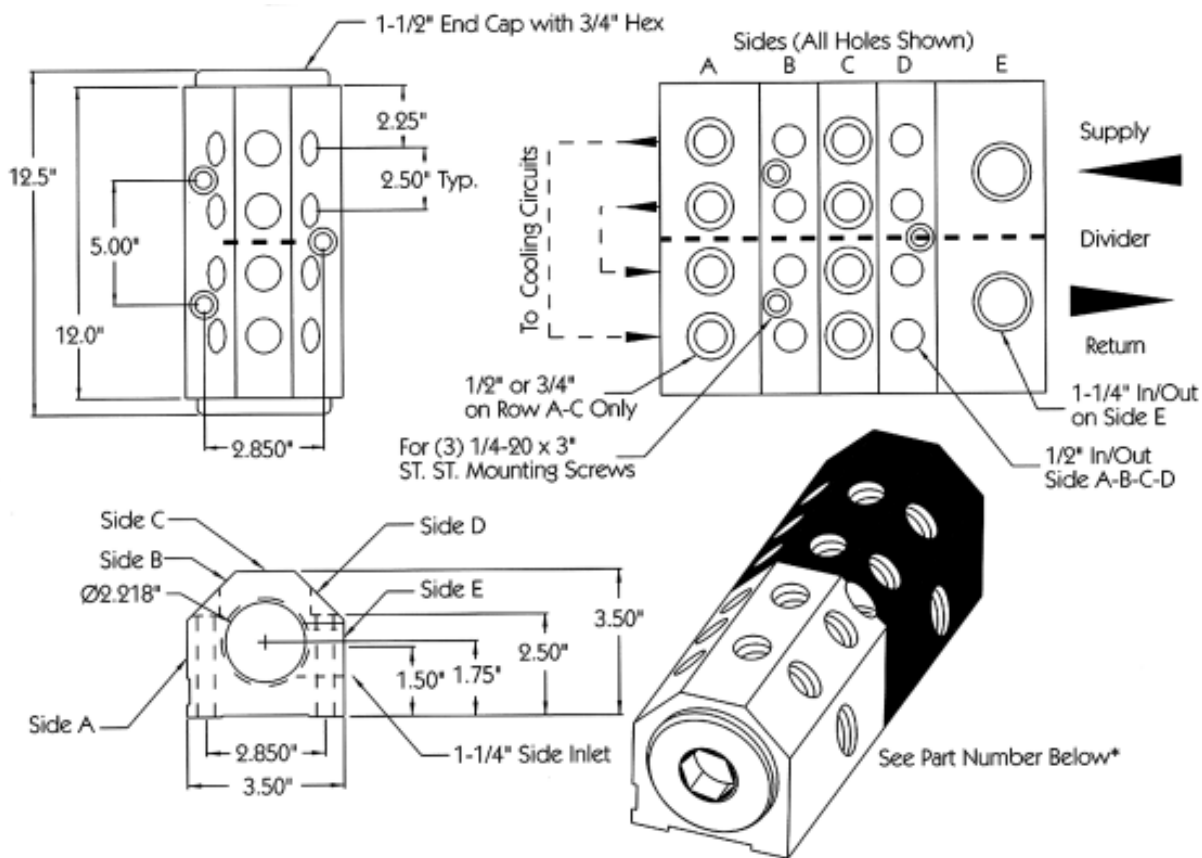

## 2" x 12" SIDELINE

Outgoing Ports					Part Number	Price
Side A In-Out	Side B In-Out	Side C In-Out	Side D In-Out	Side E-Return In-Out		
1/2" Ports	1/2" Ports	1/2" Ports	1/2" Ports			
	Two-Two			1-1/4"-1-1/4"	IM8S-12-1-1/4-B-2-2-1/2-N-R/B	\$220.00
Two-Two	Two-Two			1-1/4"-1-1/4"	IM8S-12-1-1/4-AB-4-4-1/2-N-R/B	\$244.00
	Two-Two		Two-Two	1-1/4"-1-1/4"	IM8S-12-1-1/4-BD-4-4-1/2-N-R/B	\$244.00
	Two-Two	Two-Two	Two-Two	1-1/4"-1-1/4"	IM8S-12-1-1/4-BCD-6-6-1/2-N-R/B	\$268.00
Two-Two	Two-Two	Two-Two	Two-Two	1-1/4"-1-1/4"	*IM8S-12-1-1/4-ABCD-8-8-1/2-N-R/B	\$292.00
	3/4" Ports		3/4" Ports			
	Two-Two			1-1/4"-1-1/4"	IM8S-12-1-1/4-B-2-2-3/4-N-R/B	\$220.00
	Two-Two		Two-Two	1-1/4"-1-1/4"	IM8S-12-1-1/4-BD-4-4-3/4-N-R/B	\$244.00

Prices include end caps and (3) 1/4 x 20 x 3" mounting screws

© 2009 MOLDERS CHOICE, Inc.



**24 Hour Service - 7 Days a week**  
**1-800-809-4623**  
 WebSite: [www.molderschoice.com](http://www.molderschoice.com) • Email: [molders@molderschoice.com](mailto:molders@molderschoice.com)

# STEEL WATER MANIFOLDS

*The only steel manifolds color coded for hot and cold plumbing*

## LOW COST - ECONOMY MODELS

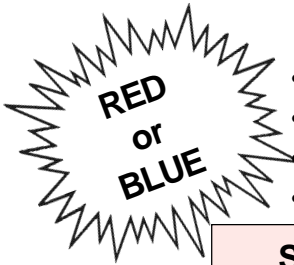

- High quality, robotically welded steel
- Pressure tested by Air @100 psi
- High visibility Red or Blue
- Compact mounting

- 2 Styles available: Straight or Split
- 2" x 2" Steel tubing
- 3/4" NPT Inlet/Outlet main supply
- 1/2" NPT Inlet/Outlet mold supply ports (2-1/2" between centers)

### Straight Through

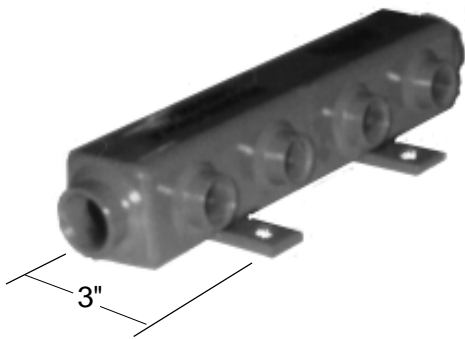

4 Port

Part # **ST4**  
**\$40.00**

OAL: 14"

Add "B" (Blue) or  
"R" (Red)  
after part number

### Split In/Out

RED and BLUE



4 Port

(2 in - 2 out)

Part # **SP422**  
**\$47.00**

OAL: 14"

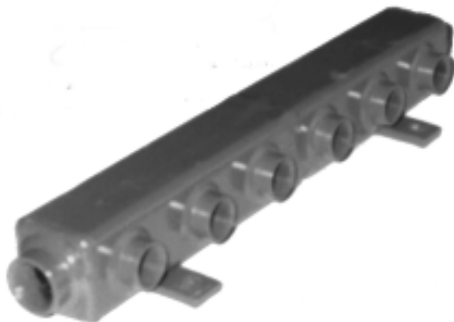

6 Port

Part # **ST6**  
**\$47.00**

OAL: 20"

Add "B" (Blue) or  
"R" (Red)  
after part number



6 Port

(3 in - 3 out)

Part # **SP633**  
**\$55.00**

OAL: 20"



8 Port

Part # **ST8**  
**\$59.00**

OAL: 26"

Add "B" (Blue) or  
"R" (Red)  
after part number



8 Port

(4 in - 4 out)

Part # **SPL844**  
**\$63.00**

OAL: 26"

© 2009 MOLDERS CHOICE, Inc.



24 Hour Service - 7 Days a week  
**1-800-809-4623**  
WebSite: [www.molderschoice.com](http://www.molderschoice.com) • Email: [molders@molderschoice.com](mailto:molders@molderschoice.com)